



PRODUCT TECHNICAL DATASHEET

G30/2204

- Optical encoder 
- Magnetic limit switch 
- 230V AC 



CODE	DESCRIPTION	PCS/PALLET
G30/2204	Electromechanical motor 230V AC irreversible ideal for sliding gates up to 2200 kg with built-in control unit H70, optical encoder and magnetic limit switch.	40

PRODUCT TECHNICAL SPECIFICATIONS	
Max gate weight	2200 kg
Power line supply	230V AC - 50Hz
Motor power supply	230V AC
Power rating	580W
Frequency of use	50%
Thrust	1500N
Operating temperature	-20+55°C
Reductor Type	Irreversible
Manoeuvre speed	9.5 m/min (0.16 m/s)
Motor thermal protection	150°C
Incorporated condenser	18 µF
Limit switch	Magnetic
Onboard control unit	H70/104AC
Encoder	Optical
Type exit gear	Z17/mod 4
Maximum dimension product in mm (L x W x H)	346 x 180 x 362
Product weight packed (Kg)	20,6
Number items per pallet	40

PRODUCT DIMENSIONS AND PREPARING FOR INSTALLATION

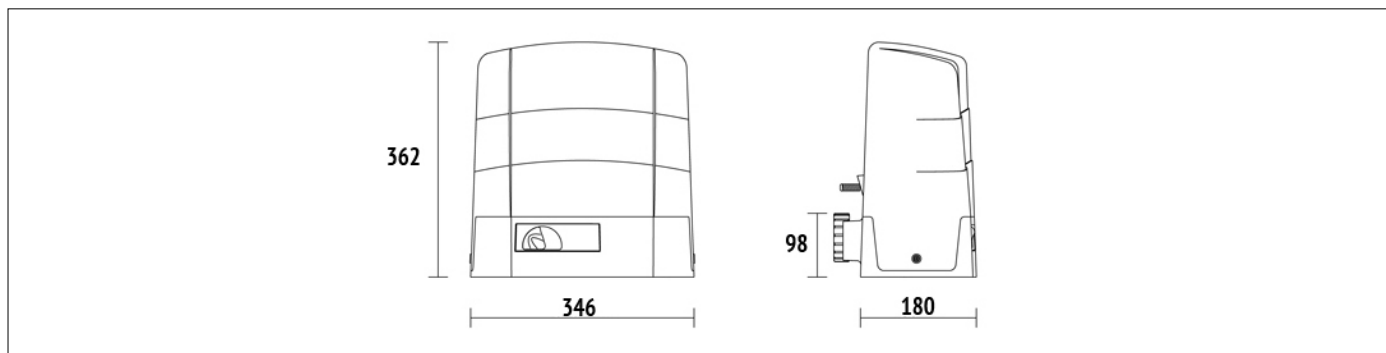

DIMENSIONS

PRODUCT PREPARING FOR INSTALLATION

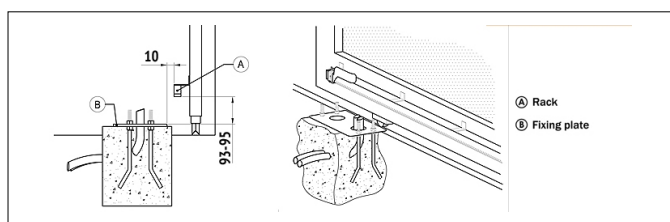

PREDISPOSITION FOR STANDARD INSTALLATION

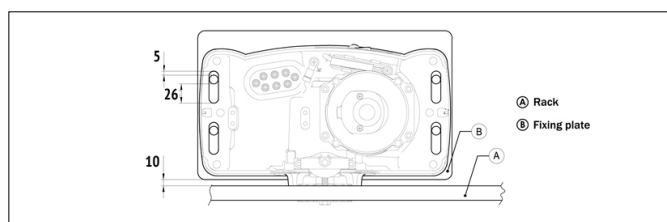

PRODUCT ACCESSORIES

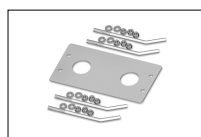

KT215
Fixing plate with stay bolts and screws G30 series.



KT222
Raised fixing plate for G30 series (+3,5 cm).



GA550
Galvanised steel rack 22x22x1000 module 4.



GA551
Galvanised steel rack 30x12x1000 module 4 with spacers and screws.



GA554
Pocket of 6 spacers (2,5 cm) and screws.

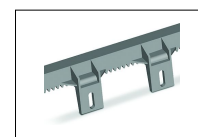

GA553
Nylon rack module 4 with 6 connectors L.1000.



GA557
Roger Technology nylon rack module 4 with 6 connectors L.1000.

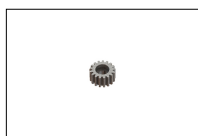

LT328
Z17 mod. 4 Pinion with increased thickness H.38 for series R30 - G30 - E30



LT331
Pinion Z11 mod. 6 only for series G30 - BG30

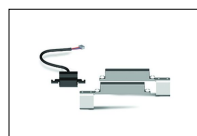

MC775
Kit magnetic limit switch for control unit H70/103AC, H70/104AC, B70/1DC, B70/1DCHP.



R99/C/001AL
Signboard "Automatic Opening" Aluminium version

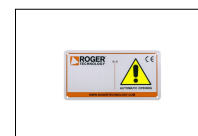

R99/C/001
Signboard "Automatic Opening".